

Roca Max Sorter

The background of the slide is a blue-tinted image of a Roca Max Sorter. It is a large, white, grid-like structure with many small compartments. Each compartment contains a card with a different illustration and text. The cards are slightly out of focus, creating a sense of depth. The overall color scheme is a monochromatic blue.

Overview for Operators

Last Edited - 01/10/2024

Topics

1. Overview of Sorting Algorithms
2. Power, Pausing, and Emergency Stop
3. Key Roca Sorter Settings
4. Maintenance
5. Basic Error Message Overview
6. Card Recognition Notes

Input Tray & Sort Algorithms



Input Tray Overview

- Don't Overfill Past Red Line
- Don't Fill "Rejection" bin
- Always use 2 handles, put Input Tray flat against the Floor of the machine, and push straight in.

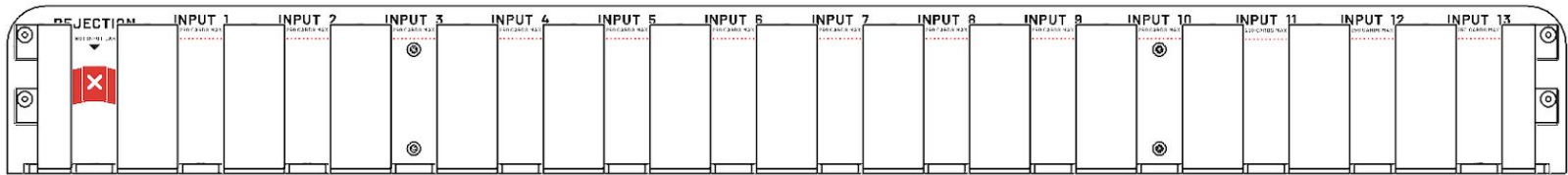
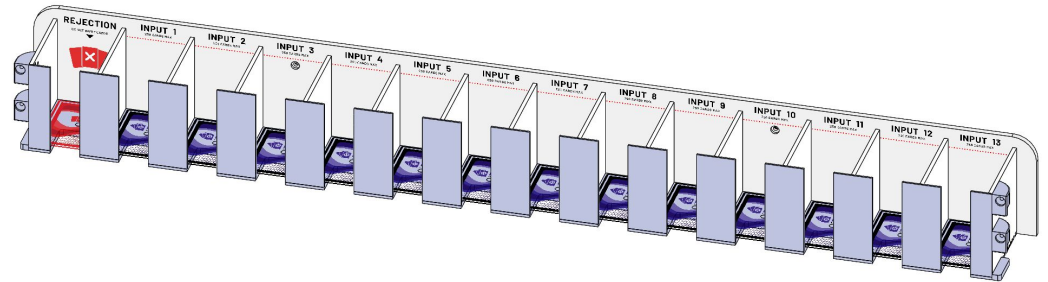

SORT Algorithm

Set, Name | Name, Set | Set, Collector Number | Color | Rarity | Other Combos Available

This algorithm will re-order the cards into a sorted card series (most commonly Set then Alphabetical by Name).

NO Green Divider Cards are Needed

Fully Load All 13 Input Tray Slots

Rejected Cards

Sorted Cards
(Continuous Card Sequence)

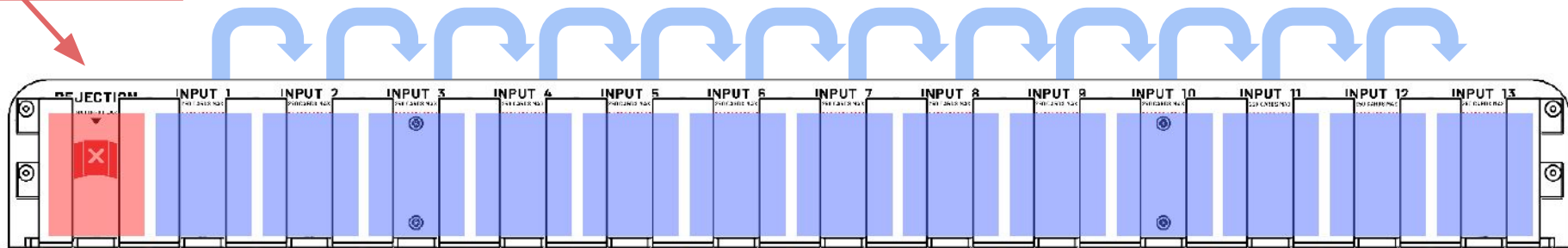

SIFT Algorithm

Bulk Sift (Price) | Bulk Sift w Rarity

This algorithm will separate
Desired/Valuable cards from
Undesired/Bulk.

2 Green Divider Cards are
Needed
Place Green Divider Cards on
top of cards in input bins

Load 1-12. **Leave 13 Open.**

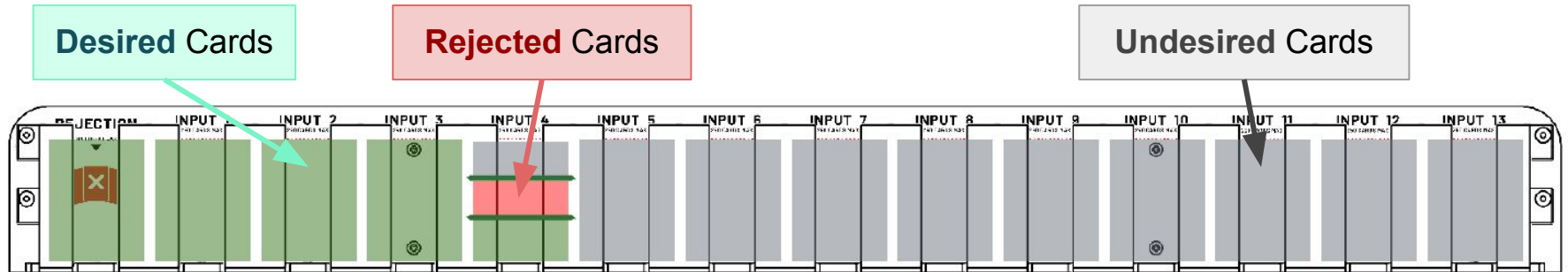

SIFT+SORT Algorithm

Price Sift, Set-Name | Price Sift, Set-Name (Sort Both)

This algorithm separates cards into categories (e.g. desired/undesired) and then sorts one or both of the categories.

1 Green Divider Card is Needed
Place Green Divider Card on top of cards in input bins

Fully Load All 13 Input Tray Slots

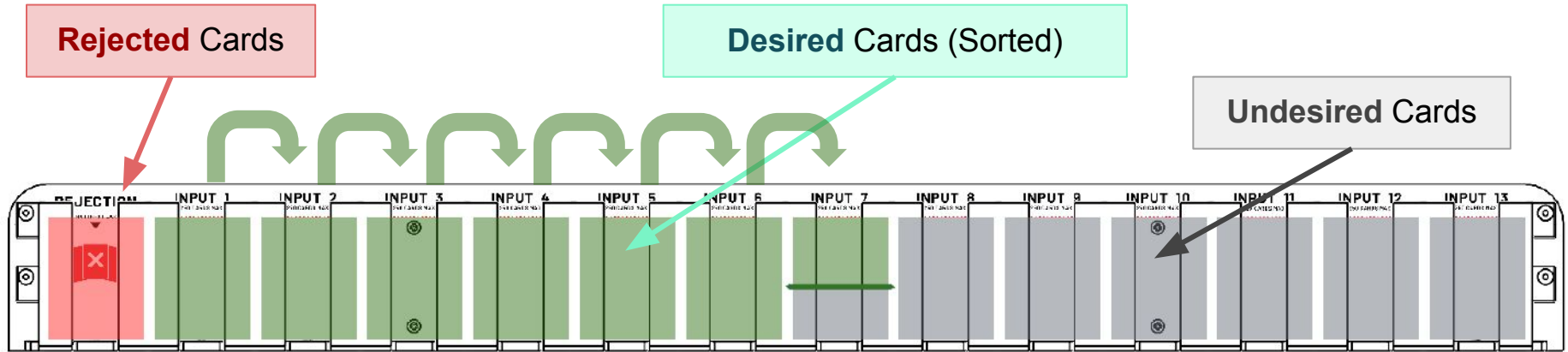



Power, Pausing, Emergency Stop

Power, Pausing, Emergency Stop

- **To power down the Roca**, press the silver button on the front and wait (~20 seconds) for the blue light to turn off. Then flip the switch on the back to fully power down.
- **If you are concerned about something, use the Emergency Stop.**
- **To Pause a Sort**, you can remove the input tray, and put it back in when ready to resume.
- **To “Abort” a Sort**, the fastest thing to do is to take out the input tray, remove all of the cards, and let the machine finish.

Foil / Condition / Language

At the start of each Sort, you should specify a Foil, Condition, and Language for the cards you are about to Sort.

Foiling	<input type="text" value="Normal"/>
Condition	<input type="text" value="Normal"/>
Language	<input type="text" value="Special Foil (Etched, Gilded, Textured, etc.)"/>
Sort Name	<input type="text" value="Demo"/>

- Normal
- Foil
- Special Foil (Etched, Gilded, Textured, etc.)
- Legacy Normal (recognize any card, prefer normal prices)
- Legacy Foil (recognize any card, prefer foil prices)

Normal / Foil / Etched Foil will only recognize cards that are available in that finish.

Legacy Normal / Legacy Foil will recognize any card.

Example - Ice Age cards, but run on Foil finish.

Set Order

When sorting by **Set**, by Default Sets will be ordered in Alphabetical order (for Magic, according to Scryfall.com names). Amonkhet → Zendikar.

This can be changed to sort by TCGplayer Order, which is roughly reverse chronological with main sets first.

Sort Ordering

Set Order:

Roca Default



Card Rejection Threshold - Recognition Confidence

As the Roca Sorter is identifying cards, it is aware of how Confident it is when deciding between similar looking cards (e.g. reprints with the same artwork across different sets). Changing the Card Rejection Threshold will cause the machine to err on the side of Rejecting cards, or taking its Best Guess.

Recognition

Card Rejection Threshold:

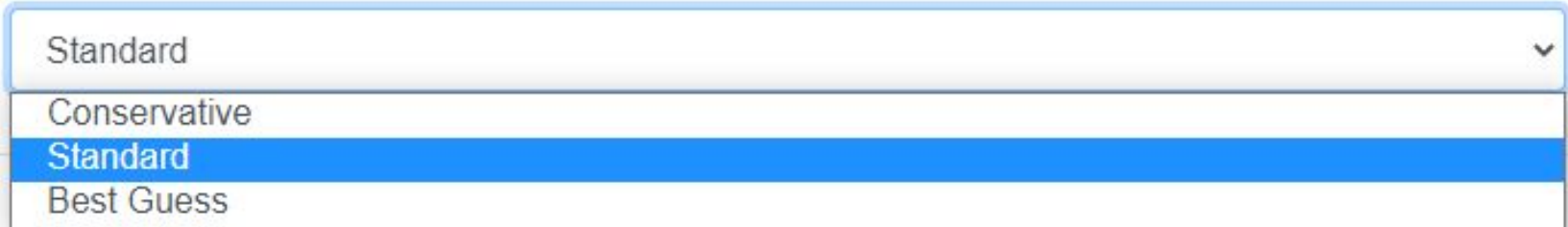

A dropdown menu with a light blue border and a white background. The menu is open, showing four options: 'Standard', 'Conservative', 'Standard', and 'Best Guess'. The second 'Standard' option is highlighted with a blue background. A small downward-pointing arrow is visible in the top right corner of the menu.

Unpriced Cards

Reject Unpriced Cards

Some cards do not have a Market Price available.

Unpriced Cards

Reject cards if price unavailable.

Especially during Sifting, it may make sense to Reject these cards. Otherwise, they will be treated as having a price of \$0.00 and will be “Undesired”.

Yusri, Fortune's Flame (MH2 Bundle)

Unique and Miscellaneous Promos



Presale Item: Ships after release date

Near Mint Foil

\$6.00

shipping: included

Power Leech Games

100% - (50000+ sales)

1

of 64

Add to Cart

PayPal Pay in 4 interest-free payments on qualifying purchases. [Learn more](#)

Price Points

Foil Printing Prices

Market Price

Buylist Market Price

Listed Median Price

Date

6/14/21

6/14/21

6/14/21

You can see the % of remaining life by going to Menu. A warning will appear when something reaches 20%.

Status

Filter life:

89%

Reset

Request

Piston life:

97%

Reset

Request

Pump life:

99%

Reset

Request

When you change out a part, press “Reset” to set the life back to 100%.

If you consume the last spare (or don't have a spare), press “Request” and we will send a new part.

Please SAVE all parts; we will provide a return shipping label for you to return them.

Filter Replacement

Filters are mounted to the Gantry

The filter can be replaced by pushing in on two sides of the ring around the tubing along with the tubing and then pull out on the tubing only while keeping the ring depressed.

To install the new filter, please press the tubing firmly into the new filter. The silver end as viewed inside the clear housing should be on the left side of the machine when it is installed.

Emptying Water Reservoir

The Water reservoir needs to be emptied after every sort.

1. Locate Water filter on front of compressor (Grey part with Blue tab)
2. Use thumb to slide down Blue tab to release water receptacle.
3. Twist gray receptacle counter clockwise and pull downward to remove
4. Empty water from receptacle and re-attach receptacle (see videos on next slide).

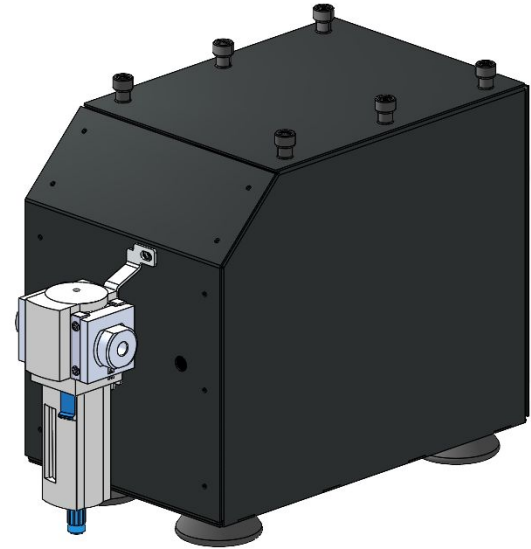

How to Remove Water Receptacle



How to Re-Attach Water Receptacle





Basic Error Message Overview

Basic Error Messages (1 of 2)





- **Card Misplaced** - the machine sees (or thinks it sees) a card not properly placed in a bin and floating on top of the sorting bins. If this occasionally happens, you can replace the card and resume sorting. ***Double check that the thumbscrews securing the piston are tight.*** If this frequently/repeatedly happens, whether or not there is actually a card misplaced, contact Roca Robotics on Slack (issue with either pneumatics or alignment).
- **Piston Not Retracted** - especially if there was an issue earlier in a sort, sometimes the machine will try to pick up a card that isn't there, and the piston will send this error message. You can put a Green Roca Divider card under the piston and try again. If it is happening frequently, contact Roca Robotics on Slack.







Basic Error Messages (2 of 2)

- **Connectivity Issues** - Try rebooting the machine. Verify that the Tablet is on the Roca Fi (or 5G) wireless network. If you can't get a connection, contact Roca Robotics on Slack.
- **Other** - We are here to help! Contact Roca Robotics on Slack.



Card Recognition Notes

Magic Card Type	Notes
The List / Mystery Booster 	The Roca will recognize cards from Mystery Booster and The List. New additions to The List are included with new set updates.
Extended Art, Showcase Cards, "Sketch" Cards, Borderless Planeswalkers 	The Roca recognizes these cards with good accuracy.
Double-Sided Cards 	The Roca will recognize a double-sided card regardless of which face is up. These cards will be alphabetized based on the primary face name.
Tokens 	The Roca will recognize tokens. For reprinted artwork on tokens, the set recognition accuracy is lower than usual.
Basic Lands 	Due to the very high number of basic land reprints, the set recognition accuracy is lower than usual.

Magic Card Type	Notes
Art Cards	 Art cards will scan, but the Roca will not distinguish between the normal and signature foil versions. All art cards will be priced as the normal versions.
Unlimited / Revised	 Accuracy distinguishing Unlimited/Revised is lower than usual, due to lack of set symbol.
Chronicles (Arabian Nights, Legends, The Dark) Anthologies (Visions, Fallen Empires, others)	 There is some identifying information, but accuracy is lower than usual.
Alpha / Beta	 Due to lack of distinguishing features (and similarity to other editions), the Roca will never classify a card as Alpha or Beta.
Foreign Black Border, 4th Foreign Black Border, Collectors Edition, Int'l Collectors	 The Roca will never classify a card as one of these sets.
Promo (planeswalker watermark) & Prerelease	 Promos and Pre-release cards will be recognized as the normal printing.

